

# LUMINOUS 172 BOARD

PIC16F72

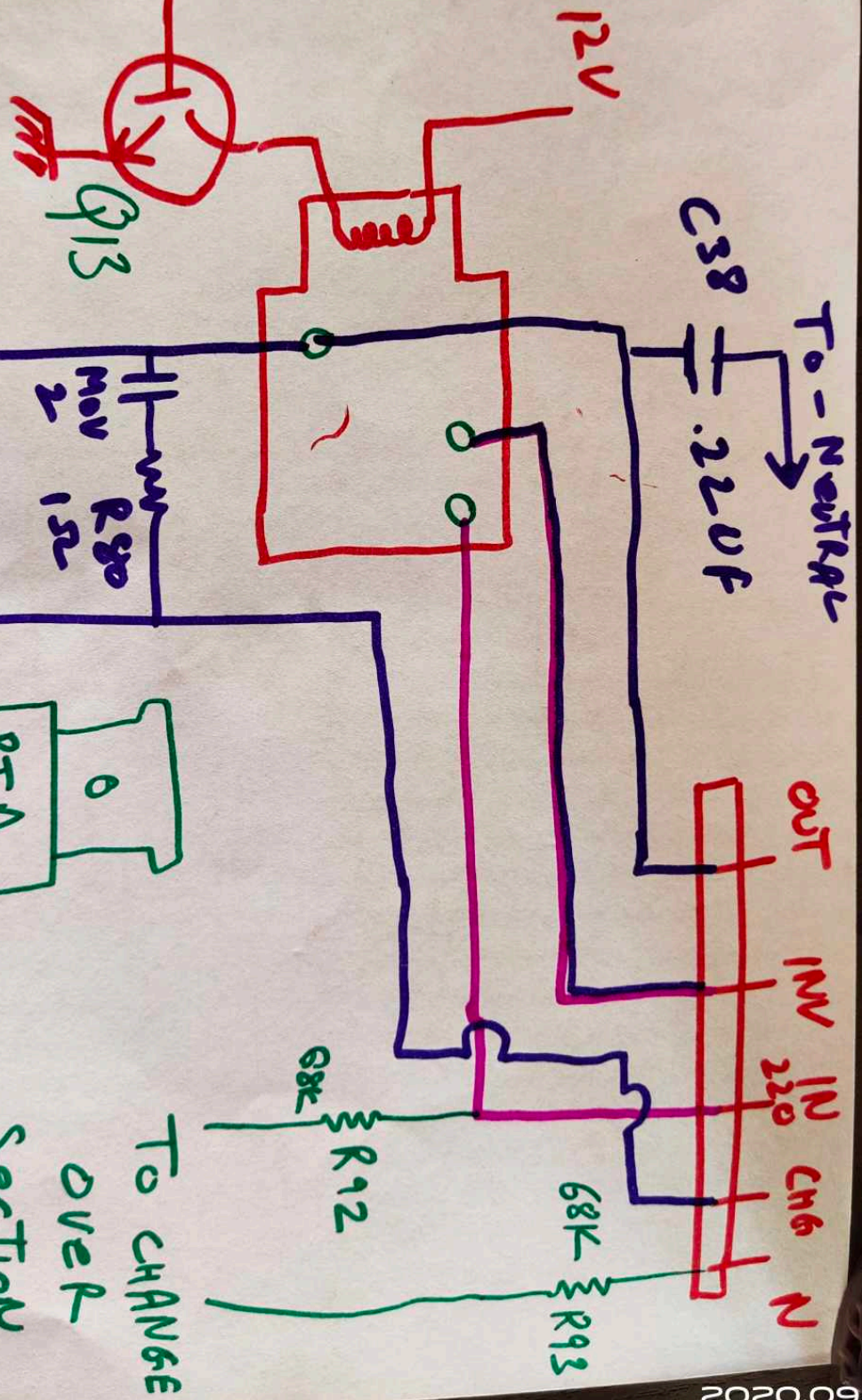

input  
voltage  
220v

charging  
140 v

neutral

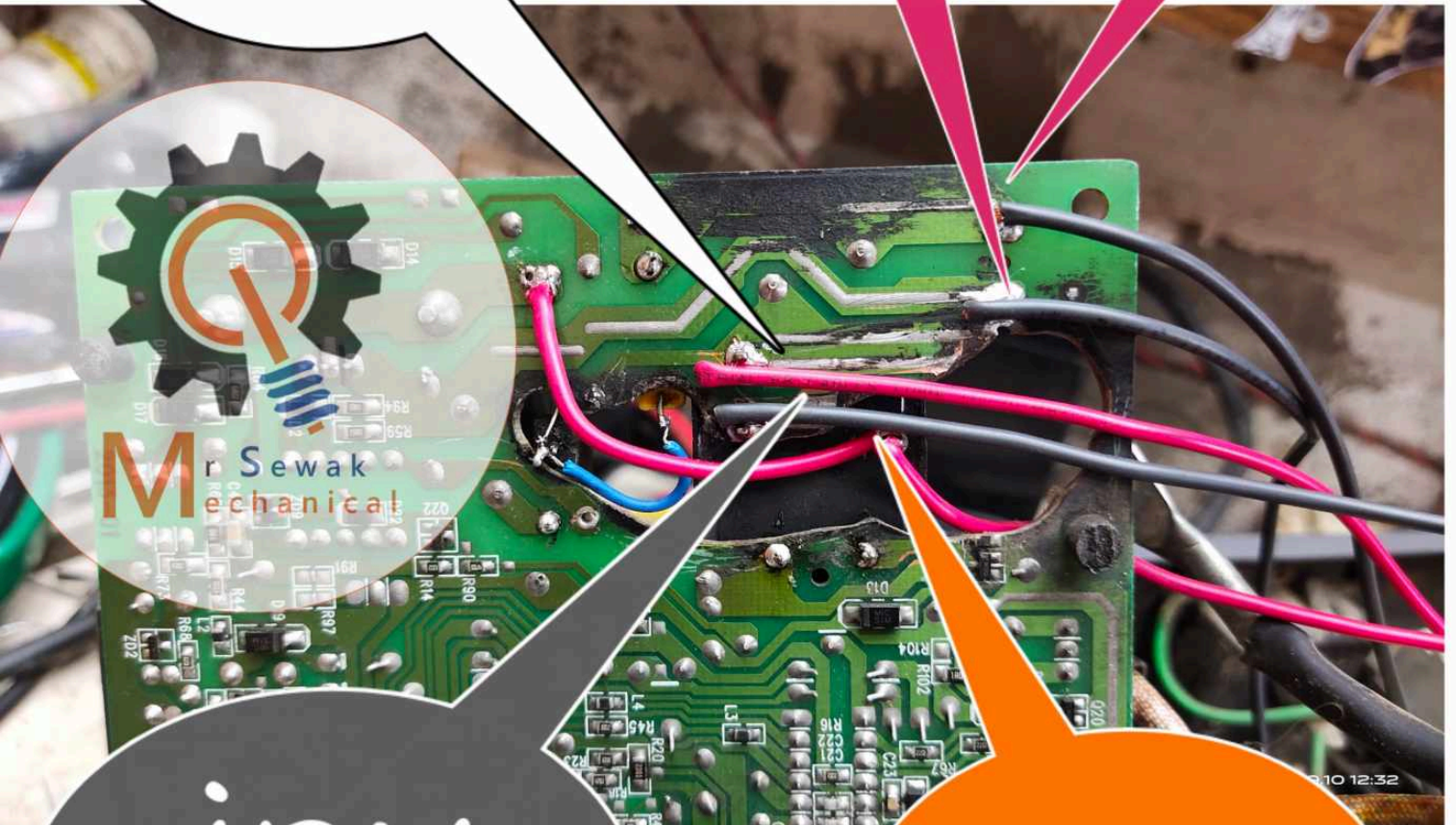

inv  
270v

out put

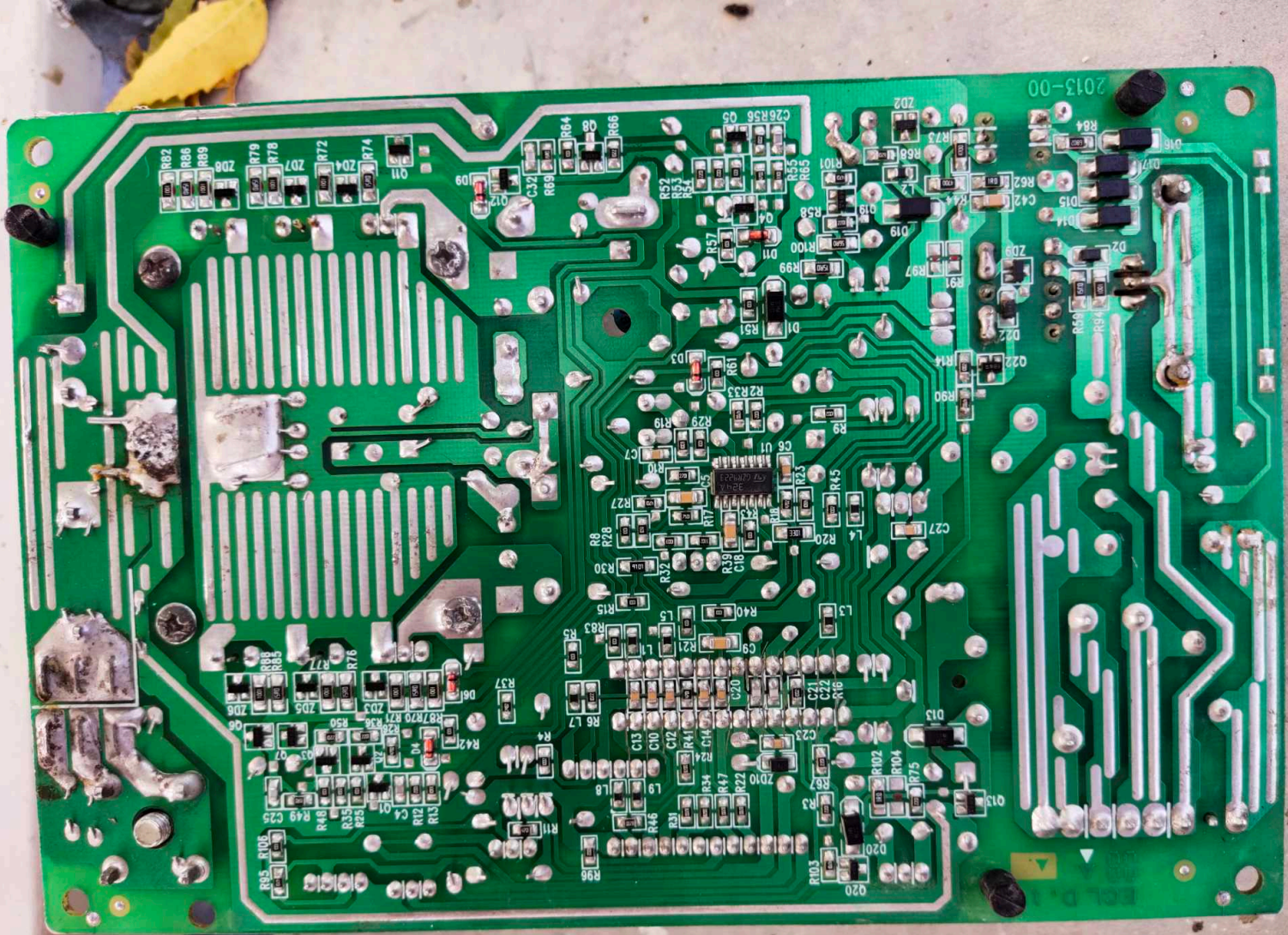

2013-00

2020.09.11 09:34

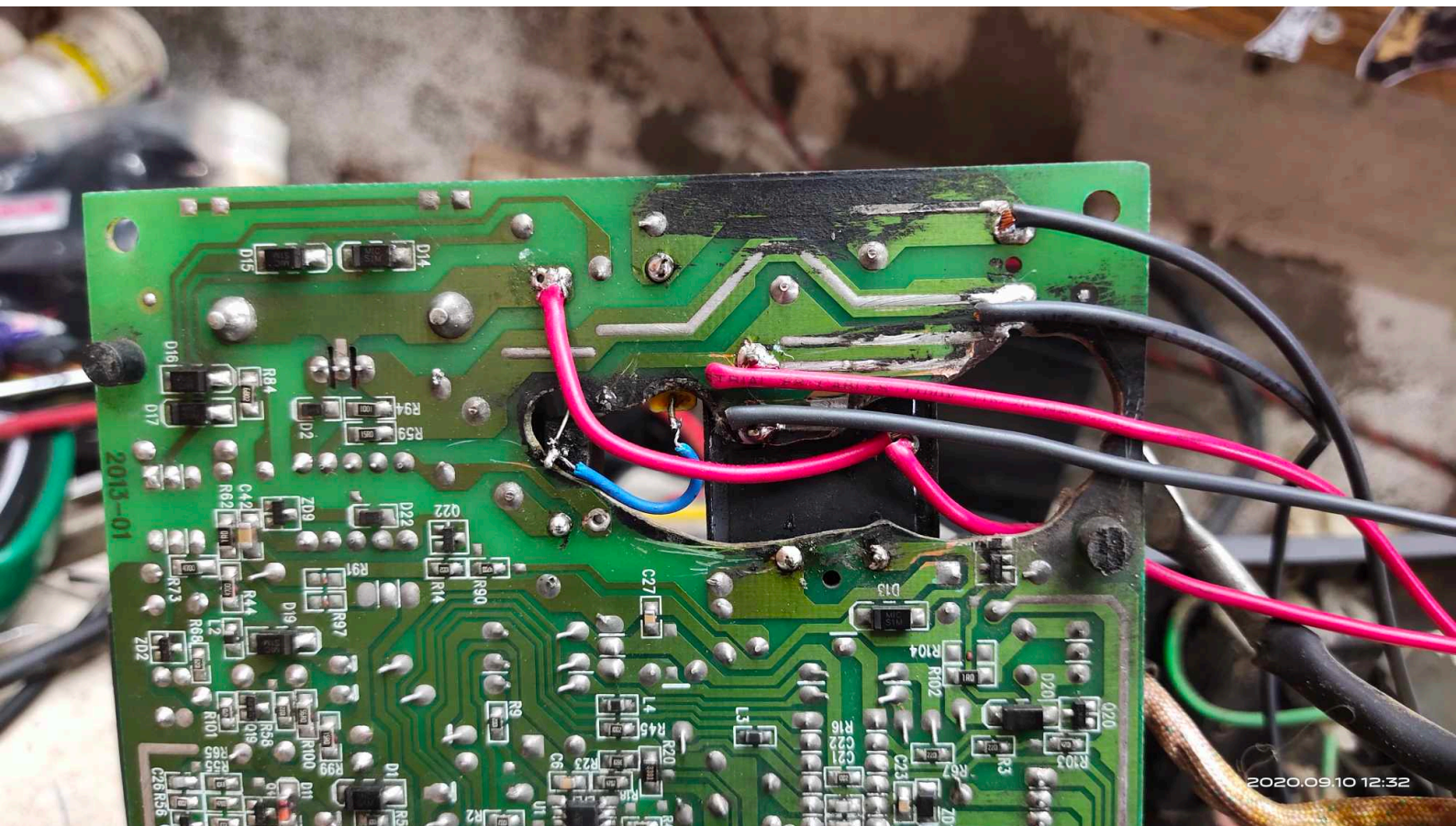

2020.09.10 12:32

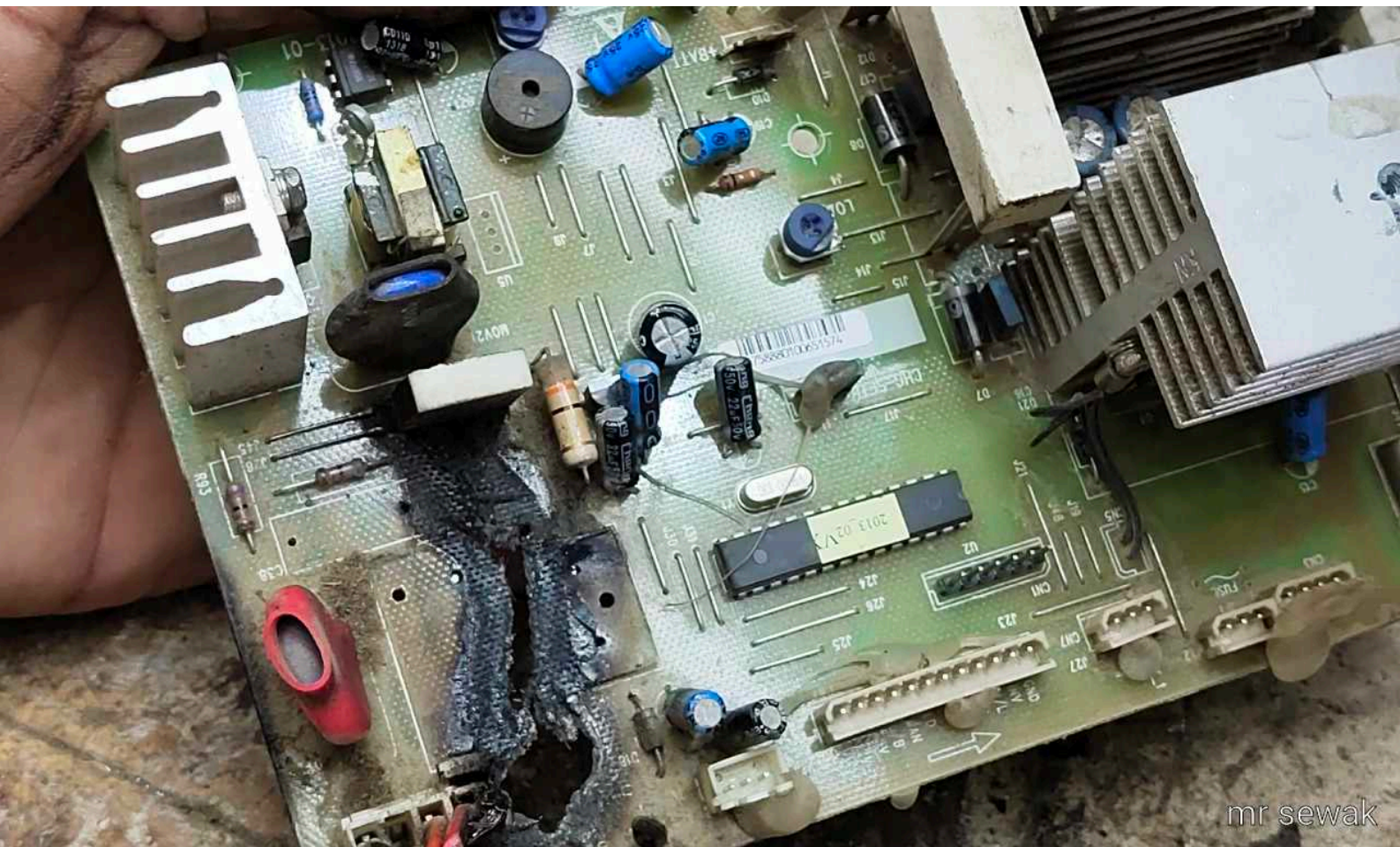

mr sewak

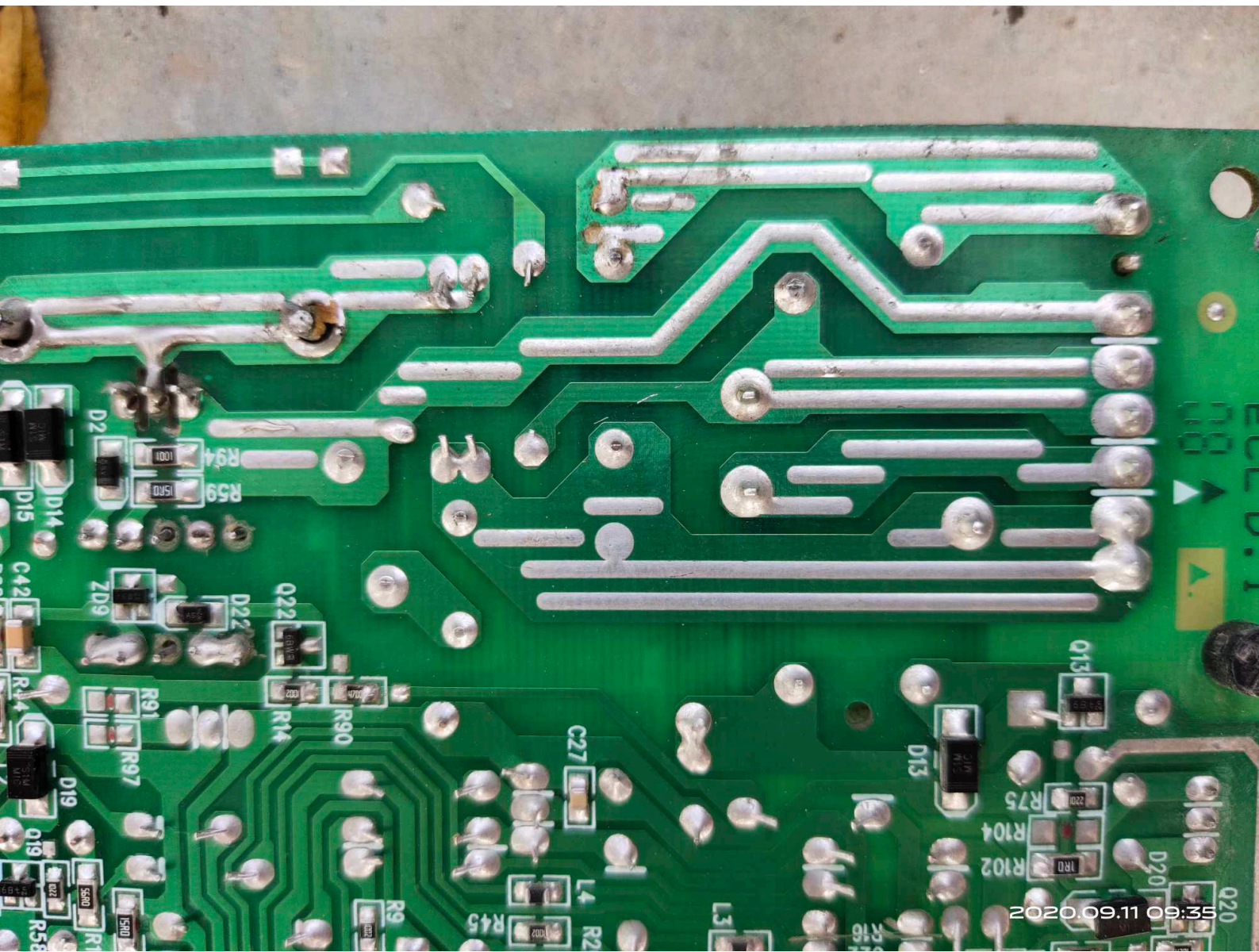



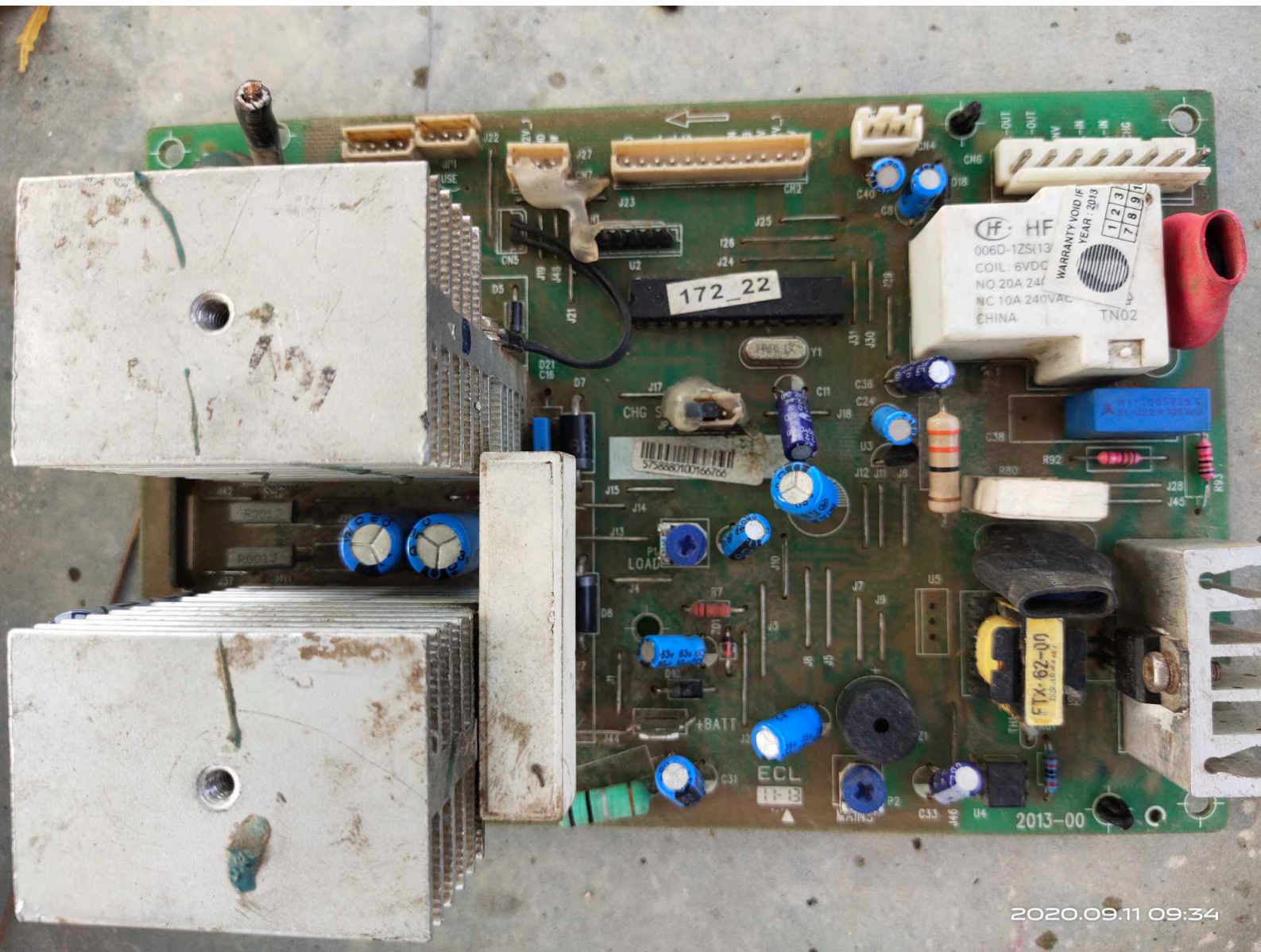

HF HF  
006D-1ZS113  
COIL 6VDC  
NO 20A 24V  
NC 10A 240VAC  
CHINA  
WARRANTY VOID IF  
YEAR: 2013  
1 2 3  
7 8 9  
TN02

172\_22

5758687100166766

F1X-62-00  
T5P-1000V AC

ECL

2013-00

2020.09.11 09:34



